

# PROTHETIK

PROTHETICS  
PROTHÈSE  
PRÓTESIS

FINEST DENTAL INSTRUMENTS

PROTHETIK/ABDRUCKLÖFFEL  
PROTHETICS/IMPRESSION TRAYS - PROTHÈSE/PORTE-EMPRESINTES - PRÓTESIS/CUBETAS PARA IMPRESIONES

# Kronenscheren

Crown scissors  
Ciseaux à couronnes  
Tijeras para coronas

**BEEBEE**  
10,5cm



**826D**  
**827D**  
**828D**  
**829D**

gezahnt/saw edge  
dentelés/dentadas



**826**  
**826D**  
spitz gerade  
sharp straight  
pointus droits  
agudas rectas



**827**  
**827D**  
stumpf gerade  
blunt straight  
moussees droits  
romas rectas



**828**  
**828D**  
gebogen  
curved  
courbes  
curvas

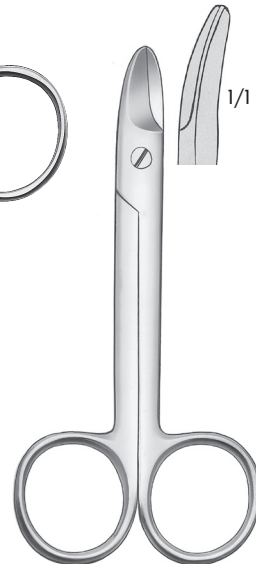

**829**  
**829D**  
gebogen  
curved  
courbes  
curvas

# Kronenscheren

Crown scissors  
 Ciseaux à couronnes  
 Tijeras para coronas

**Kronenschere mit schmalem Blatt für enge Kronenringe**

**Crown scissors with one small blade for cutting narrow crown-rings**

**Ciseaux à couronnes avec une lame très effilée pour la taille de bagues étroites**

**Tijeras para coronas con un lado estrecho**



**828 1/2**  
10,5cm

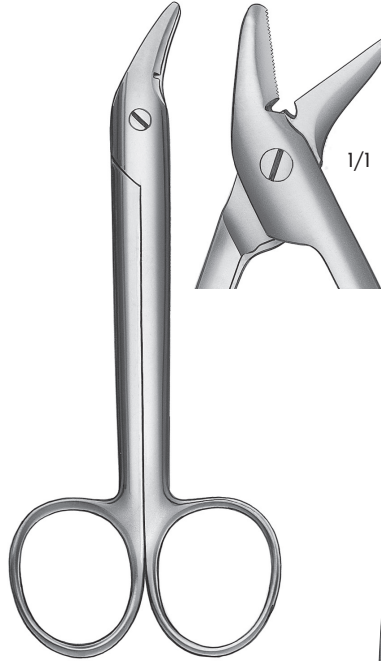

**826 1/2**  
12cm  
**Universal**  
gerade/straight  
droits/rectas



**825**  
9cm  
gebogen/curved  
courbes/curvas



**804**  
12cm  
gerade/straight  
droits/rectas

**Folienschere für Keramik**  
**Foil scissors for ceramics**  
**Ciseaux pour feuilles d'or**  
**Tijeras para hojas de oro**

**PROTHETIK/ABDRÜCKLÖFFEL**  
 PROTHETICS/IMPRESSION TRAYS - PROTHÈSE/PORTE-EMPRIENTES - PROTÉSIS/CUBETAS PARA IMPRESIONES

FINEST DENTAL INSTRUMENTS

# Kronenabnehmezange

Crown remover

Pince à desceller les couronnes

Instrumentos para quitar coronas

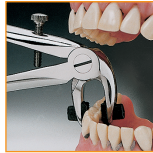

- für VMK-Kronen und -Brücken mit austauschbaren, weichen Kunststoffbacken - speziell für Einproben (sterilisierfähig bis 180° C).
- for ceramical and plastic crowns and bridges, with soft plastic inserts (sterilization up to 180° C).
- pour couronnes et bridges en ceramique ou plastiques, avec des protections souples de plastique, interchangeables (stérilisation jusqu'à 180° C).
- para coronas y puentes cerámicas o plásticas con capa de plástico elástico (esterilización hasta 180° C).



**1109**  
**LINDBLOM**

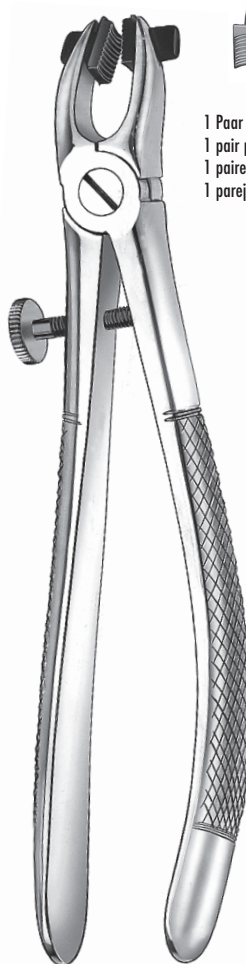

**1165/1**



**1165A**

- 1 Paar Kunststoffbacken
- 1 pair plastic inserts
- 1 paire de protections
- 1 pareja de capas de plástico

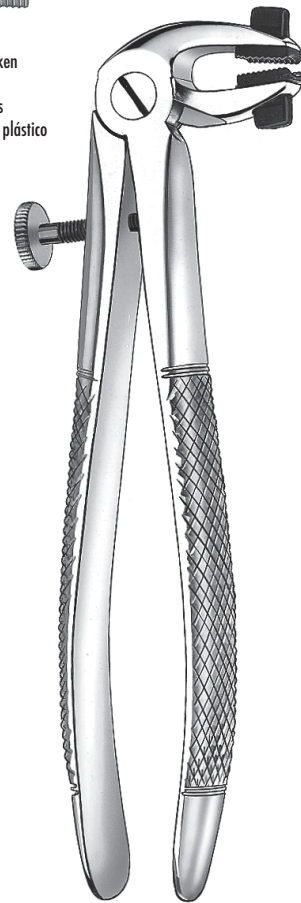

**1165/2**



# Kronenabnehmer

Crown removers

Instruments à détacher les couronnes

Instrumentos para quitar coronas

## Kronenabnehmerzange 1166

- Für die schonende und sichere Entfernung von prov. Kronen und Brücken
- Mit Hartmetalleinlagen
- Länge 18cm mit gebogener Spitze

Vorteil: Der Scherengriff erlaubt ein sehr gefühllvolles Lösen von Kronen und Brücken. Die sehr rutschsicheren und abnutzungsarmen Hartmetallbacken liegen fest an. Durch eine Gesamtlänge von 18cm und der gebogenen Spitze, lässt sich die Zange sehr sicher in der Mundhöhle bewegen.

## Crown removal forceps, 1166

- For minimally invasive, safe removal of temporary crowns and bridges
- Inlaid with tungsten carbide
- Length 18cm with curved tip

Advantage: The scissor grip enables crowns and bridges to be loosened very gently. The exceptionally sure-grip, low-wear tungsten carbide jaws provide a secure grip. The overall length of 18cm and the curved tip ensure very safe movement of the forceps in the oral cavity.

## Pince arrache-couronne 1166

- Pour la dépose en douceur et en toute sécurité de couronnes et de bridges provisoires
- Avec plaquettes rapportées en carbure
- Longueur 18cm et extrémités courbes

Avantage: Le manche du type ciseaux permet de déposer les couronnes et bridges avec délicatesse. Les mors en carbure à effet anti-dérapant et peu sujets à l'usure s'appliquent fermement. Du fait de sa longueur totale de 18cm et de la courbure de ses extrémités, la pince se laisse manipuler en toute sécurité dans la cavité buccale.

## Tenazas para extraer coronas 1166

- Para la remoción cuidadosa y segura de coronas y puentes provisionales
- Con inserciones de carburo de tungsteno
- Largo 18cm, con punta curva

Ventaja: El mango de tijera permite soltar coronas y puentes con mucho tacto. Las mordazas de carburo de tungsteno, muy antideslizantes y de desgaste reducido, se adaptan firmemente. Gracias a la longitud total de 18cm y a la punta curva, las tenazas se desenvuelven con mucha seguridad en la cavidad bucal.

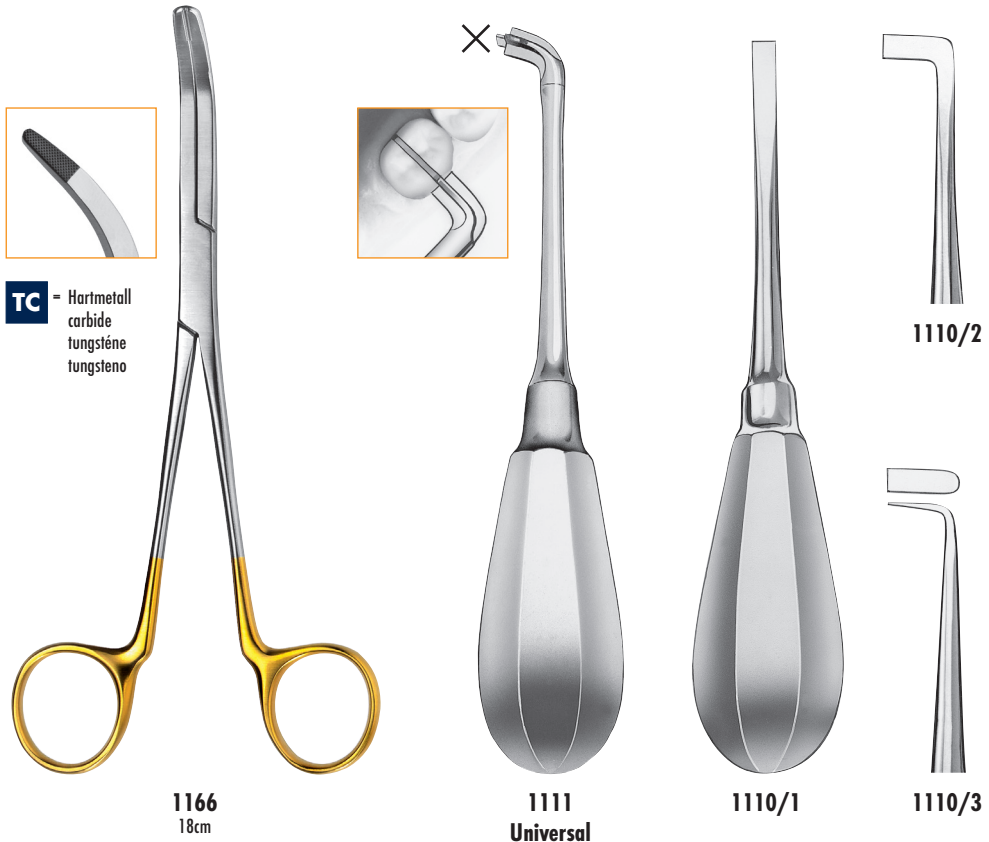

# Kronenabnehmer

Crown removers

Instruments à détacher les couronnes

Instrumentos para quitar coronas

## Kronenabnehmer AutoRem 1105

- Automatischer Kronen- und Brückenabnehmer zur Entfernung von provisorischem und feststehendem Zahnersatz
- Die Impulsstärke ist in 3 Stufen einstellbar

· Der Artikel 1105 wird incl. 3 Abnehmerhaken  
+ 1 Montageschlüssel geliefert

## Crown remover AUTOREM 1105

- Automatic crown and bridge remover for removal of temporary and fixed restorations
- Removal force can be set to 3 levels

· Order no. 1105 is supplied with 3 remover hooks  
+ 1 assembly key

## Arrache-couronne AUTOREM 1105

- Arrache-couronne / bridge automatique pour la dépose de provisoires et de prothèses fixes
- La force d'impulsion est réglable selon 3 degrés

· L'article 1105 est fourni avec 3 crochets + 1 clé de montage

## Extractor de coronas AUTOREM 1105

- Extractor automático para coronas y puentes, para levantar prótesis dentales provisionales y fijas
- La intensidad del impulso puede regularse en 3 niveles

· El artículo 1105 se suministra con 3 ganchos extractores



1105



1105A

im Set mit 3 Ansätzen wie abgebildet  
Set of 3 stems, as shown  
Set avec 3 embouts comme illustré  
Juego con tres puntas según imagen

# Zangenständer

Forceps rack

Support pour pinces

Soporte para pinzas

## Zangenständer

- rostfrei
- mit rutschfestem Silikon für einen sicheren Stand
- für die Aufnahme von 6-8 Zangen
- sehr gut in der Kieferorthopädie geeignet

## Forceps rack

- Stainless
- Includes non-slip silicone for a firm footing
- Holds 6 - 8 pairs of forceps
- Very useful for orthodontics

## Support pour pinces

- inoxydable
- avec gaines de silicone antidérapantes pour une bonne stabilité
- pour 6 à 8 pinces
- très bien adapté pour l'orthopédie dentofaciale

## Soporte para pinzas

- inoxidable
- con silicona antideslizante para una colocación segura
- permite alojar entre 6 y 8 pinzas
- muy indicado para la ortodoncia

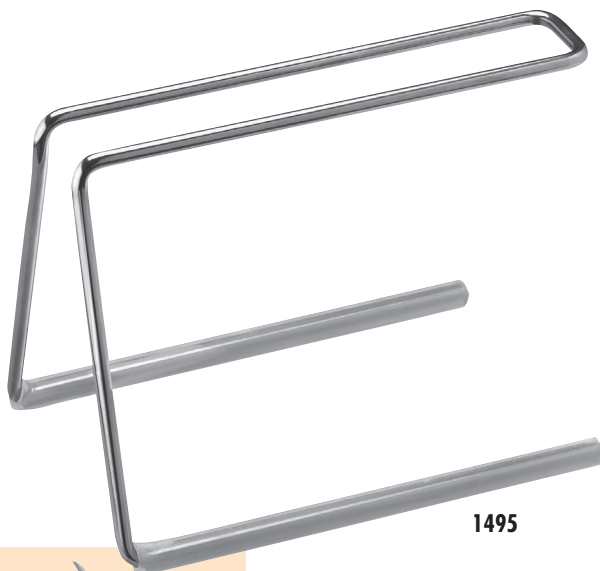

1495



# Pinzetten

Tweezers  
Précelles  
Pinzas

## Diamantierte Spitzen

Diamond-tipped · Pointes diamantées · Puntas de diamante

- Pinzetten mit diamantierten Spitzen
- ermöglicht ein sicheres Fassen von allen metallischen und keramischen Teilen (z. B. Inlays)
- besonders vorteilhaft beim Aufbrennen von Vollkeramik (kein Metallabrieb/keine Schwarzverfärbung)
- Tweezers with diamond-coated tips
- Grip all metallic and porcelain objects (e.g. inlays) firmly
- Especially useful when firing all-ceramic systems (no metal abrasion or black discoloration)

- précelles à pointes diamantées
- permettent de saisir sûrement toutes les pièces métalliques et céramiques (par ex. les inlays)
- utilisation particulièrement avantageuse lors de la cuisson des céramo-céramiques (pas d'abrasion de métal/pas de coloration noire)
- pinzas con puntas diamantadas
- permiten asir de forma segura todas las piezas metálicas y cerámicas (p.ej. inlays)
- particularmente ventajosas para la aplicación de cerámica sin metal (no producen abrasión metálica ni decoloración negra)



651 1/2D  
15cm



708  
15cm



773D  
15cm



773CD  
15cm

# Flachzangen/Rundzangen

Flat nose pliers/Round nose pliers  
 Pincès à mors plats/Pincès ronds  
 Alicates de picos chatos/Alicates redondos

PROTHETIK/ABDRÜCKLÖFFEL

PROTHETICS/IMPRESSION TRAYS - PROTHÈSE/PORTE-EMPRESSES - PROTÈSES/CUBETAS PARA IMPRESIONES



**1326**  
13cm



**1326 1/2**  
14cm

für federharten Draht bis max. 0,7mm  
 for hard wire up to max. 0,7mm

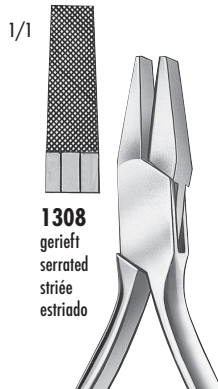

1/1

**1308**  
gerieft  
serrated  
striée  
estriado

13cm

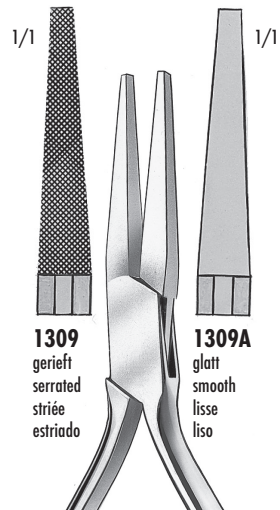

1/1

**1309**  
gerieft  
serrated  
striée  
estriado

**1309A**  
glatt  
smooth  
lisse  
liso

14cm

FINEST DENTAL INSTRUMENTS



# Flachzangen

Flat nose pliers  
Pincers à mors plats  
Alicates de picos chatos

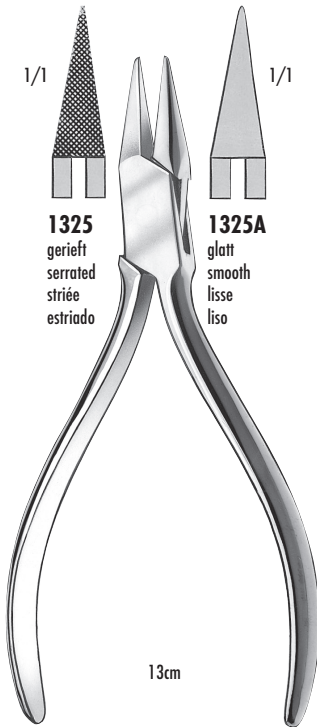

## **DUROLINE**

- Spezialstahl mit hoher Materialhärte
- klinisch getestet im kieferorthopädischen Dauereinsatz
- high-tempered special steel
- clinical approved

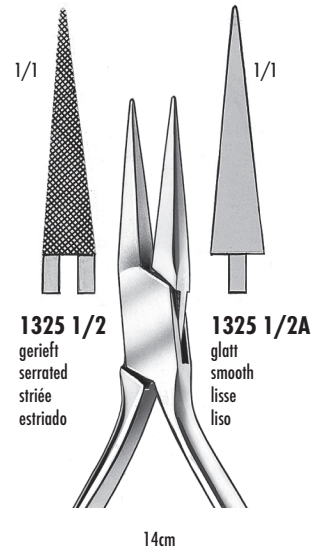

für federharten Draht bis max. 0,7mm  
for hard wire up to max. 0,7mm

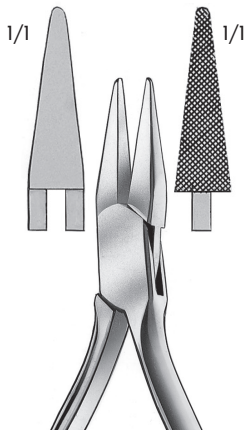

**1327**  
13cm  
**GOSLEE**  
glatt/gerieft  
smooth/serrated  
lisse/striée  
liso/estriado

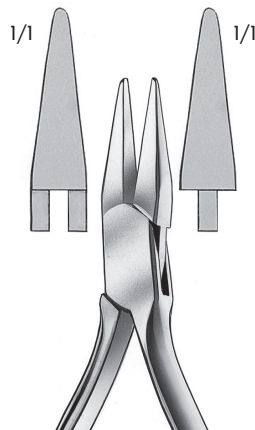

**1327A**  
13cm  
**GOSLEE**  
glatt  
smooth  
lisse  
liso

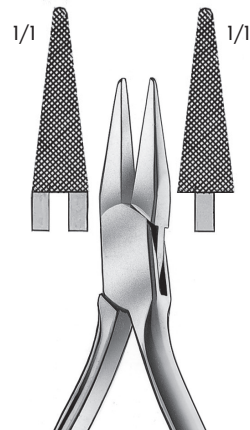

**1327B**  
13cm  
**GOSLEE**  
gerieft  
serrated  
striée  
estriado

# Klammerbiegeezangen

Clasp bending pliers  
Pincès à courber les crochets  
Alicates para doblar ganchos

PROTHETIK/ABDRÜCKLÖFFEL

PROTHETICS/IMPRESSION TRAYS - PROTHÈSE/PORTE-EMPRIENTES - PROTÈSES/CUBETAS PARA IMPRESIONES



**ADERER**

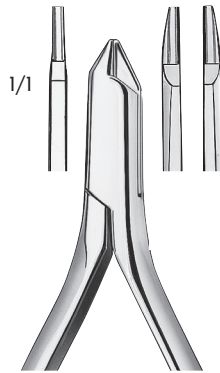

**1234**  
11,5cm  
**ADERER**

max. 0,7mm  
hart/hard/dur/duro

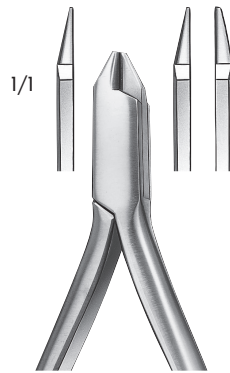

**1234A**  
12cm  
**ADERER**

max. 0,7mm  
hart/hard/dur/duro

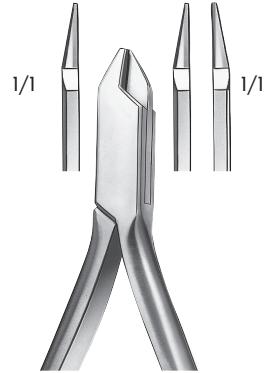

**1234B**  
12cm  
**ADERER**

max. 0,9mm  
hart/hard/dur/duro

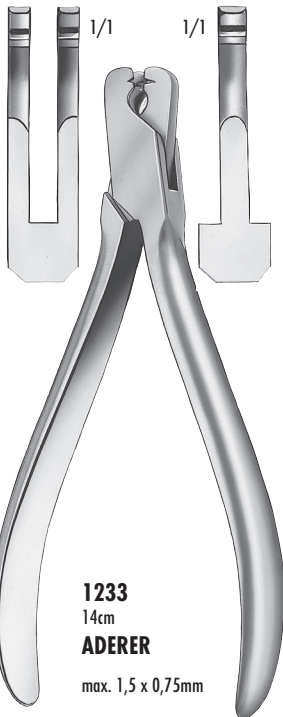

**1233**  
14cm  
**ADERER**

max. 1,5 x 0,75mm

**Pfeilformzange**  
**Arrow Clasp Former**  
**Pince à former les crochets**  
**Alicates para formar ganchos**

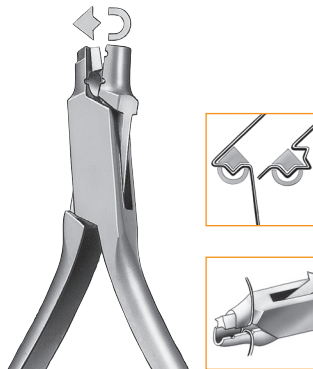

**1237**  
13cm  
**SCHWARZ**

max. 0,7mm  
hart/hard/dur/duro

**Pfeilknickzange**  
**Arrow Clasp Bending Pliers**  
**Pince à courber les crochets**  
**Alicates para doblar ganchos**

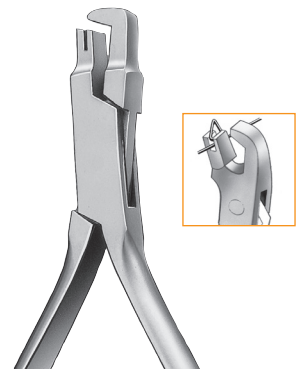

**1238**  
13cm  
**SCHWARZ**

max. 0,7mm  
hart/hard/dur/duro

FINEST DENTAL INSTRUMENTS

# Hohlkehlzangen

Wire bending pliers  
 Pincès à courber les fils  
 Alicates para doblar alambre

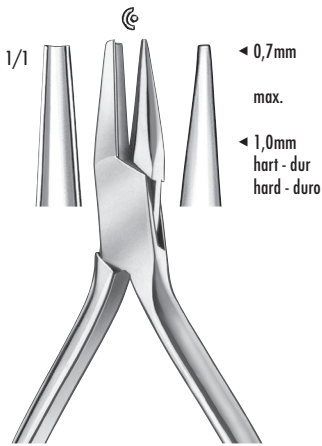

**1264**  
13cm

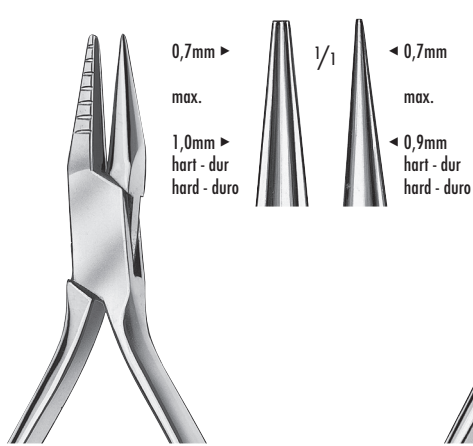

**1239**  
14cm  
**SCHWARZ**

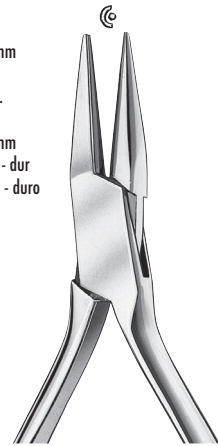

**1239A**  
14cm  
**SCHWARZ**



**1236**  
13cm

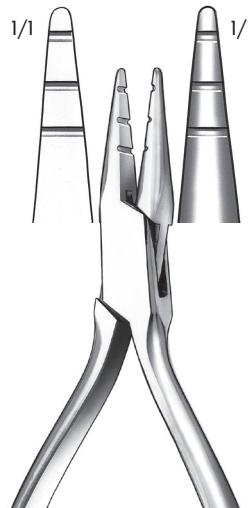

**1290**  
14cm  
**ADERER**

**PROTHETIK/ABDRÜCKLÖFFEL**  
 PROTHÈSES/IMPRESSON TRAYS - PROTHÈSES/PORTE-EMPRESSES - PROTÉSIS/CUBETAS PARA IMPRESIONES

FINEST DENTAL INSTRUMENTS

# Universal-Kramponzangen/Klammerbiegezangen

Universal pin bending pliers/Clasp bending pliers  
 Pincas universelles/Pincas à courber les crochets  
 Alicates universales para espigas/Alicates para doblar ganchos

PROTHETIK/ABDRUCKLÖFFEL

PROTHETICS/IMPRESSION TRAYS - PROTHÈSE/PORTE-EMPRIENTES - PROTÈSE/CUBETAS PARA IMPRESIONES

FINEST DENTAL INSTRUMENTS



**1300**  
15cm

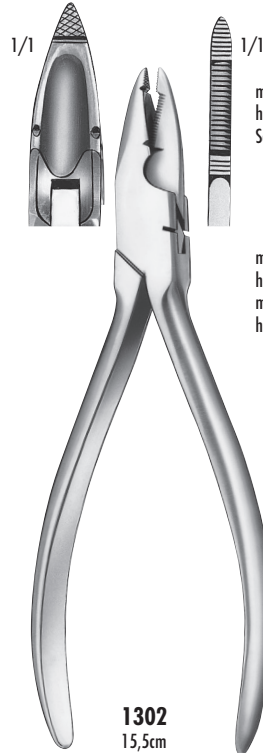

**1302**  
15,5cm  
**WALDSACHS**

max. 0,7mm  
 hart/dur/hard/duro  
 Schneiden/cutting/couper/cortar

max. 1,0mm  
 hart/dur/hard/duro  
 max. 1,3 x 0,65mm  
 hart/dur/hard/duro

**1300 - 1301**

Biegen/bending/  
 plier/doblar  
 max. 0,9mm hart/dur/  
 hard/duro

Schneiden/cutting/  
 couper/cortar  
 max. 0,7mm hart/dur/  
 hard/duro

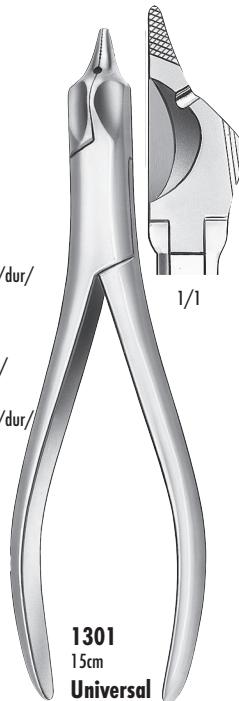

**1301**  
15cm  
**Universal**

# Drahtbiegezangen/Kieferorthopädie

Wire bending pliers/Orthodontic  
 Pincès à courber les fils/L'orthodontie  
 Alicates para doblar alambre/Ortodoncia

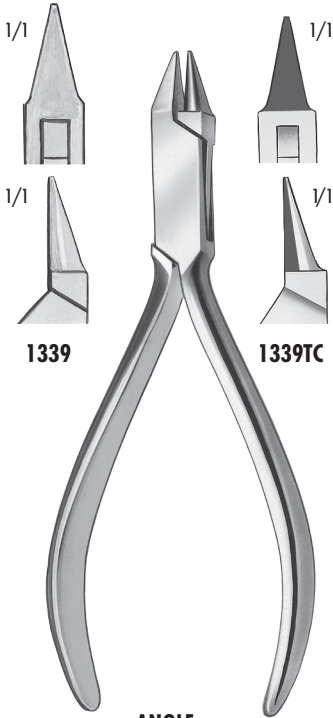

**1339**

**1339TC**

**ANGLE**  
13cm



**1340**

**1340TC**

**ADAMS**

max. 0,8mm hart/dur  
hard/duro

**1339, 1340, 1342**  
max. 0,7mm hart/dur/hard/duro

**1339TC, 1340TC**  
max. 0,7mm federhart/springhard

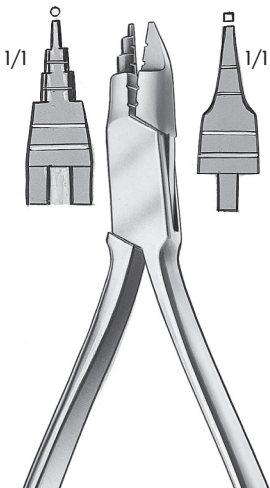

**1342**  
14cm  
**YOUNG**

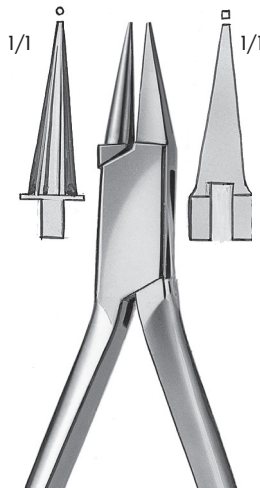

**1341/65**  
15cm

**PROTHETIK/ABDRUCKLÖFFEL**  
 PROTHETICS/IMPRESSION TRAYS - PROTHÈSE/PORTE-EMPRIENTES - PROTÉSIS/CUBETAS PARA IMPRESIONES

FINEST DENTAL INSTRUMENTS



# Konturenzangen/ Kronenstreckzangen

Contouring pliers/Crown stretching pliers/Crimping pliers  
Pinces à bouteroller/Pinces à étendre les couronnes  
Alicates p. contornear/Alicates p. ensanchar coronas

PROTHETIK/ABDRUCKLÖFFEL

PROTHETICS/IMPRESSION TRAYS - PROTHÈSE/PORTE-EMPRESSES - PROTÉSIS/CUBETAS PARA IMPRESIONES

FINEST DENTAL INSTRUMENTS

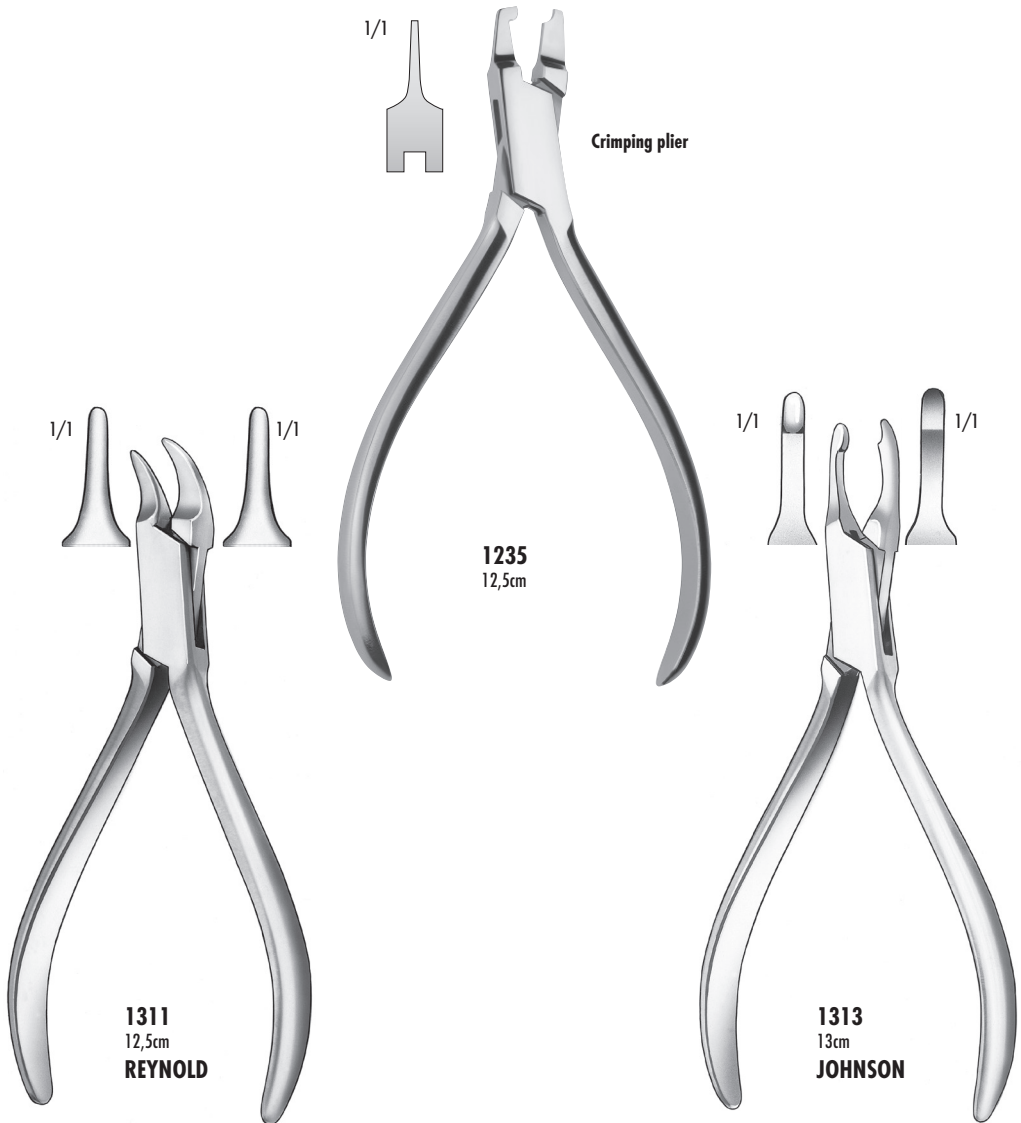

# Lineal/Tasterzirkel/Schiebelehre

Metal ruler/Calipers/Caliper rule  
 Jauge de niveau graduée/Compas d'épaisseur/Pied à coulisse  
 Regla metálica/Calibradores/Pie de rey

PROTHETIK/ABDRÜCKLÖFFEL

PROTHETICS/IMPRESSION TRAYS - PROTHÈSE/PORTE-EMPRESSES - PROTÉSIS/CUBETAS PARA IMPRESIONES



**1597**  
15cm

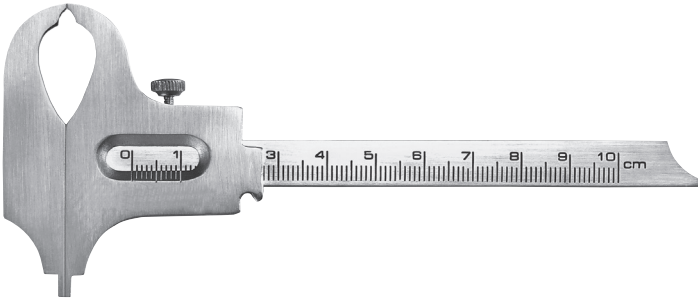

**1596**  
BOLEY

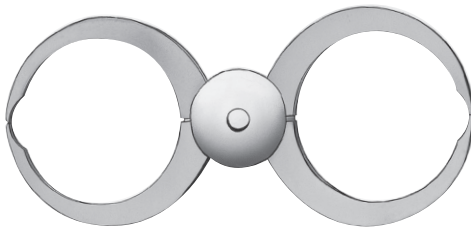

**1592**



**1594**  
10cm  
**IWANSON**  
für Metall  
for metal  
pour métal  
para metal



**1595**  
10cm  
**IWANSON**  
für Wachs  
for wax  
pour cire  
para cera

Zehntelmaß  
 Decimal caliper  
 Calibre décimal  
 Calibrador decimal

doppelseitige Skala  
 calibrated on both sides  
 échelle de deux côtés  
 escala de ambos lados

FINEST DENTAL INSTRUMENTS

carl  
martin  
Solingen

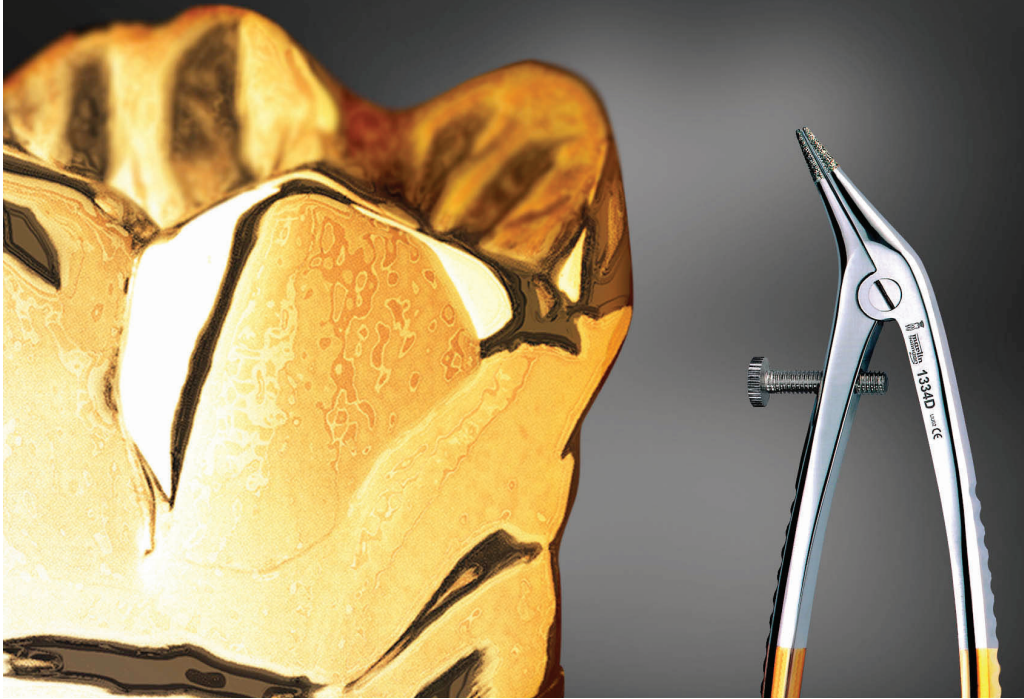

[www.carlmartin.de](http://www.carlmartin.de)

F I N E S T   D E N T A L   I N S T R U M E N T S

**PROTHETIK/ABDRUCKLÖFFEL**  
PROTHETICS/IMPRESSION TRAYS - PROTHÈSE/PORTE-EMPRIENTES - PROTÉSIS/CUBETAS PARA IMPRESIONES

F I N E S T   D E N T A L   I N S T R U M E N T S